

# Funkisbastu 15m<sup>2</sup>



Tel. +46 952 12222  
E-Mail: info@sorselestugan.se www.sorselestugan.se

Ver. 1.0

Skala 1:100 om ej annan anges.

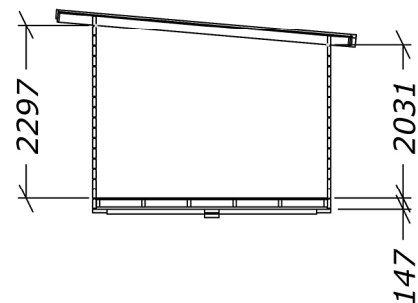
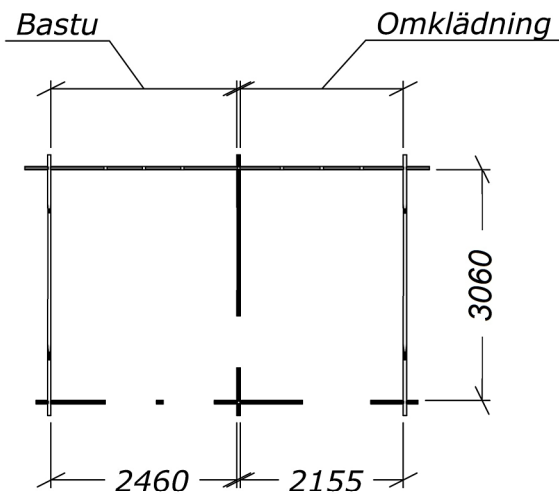
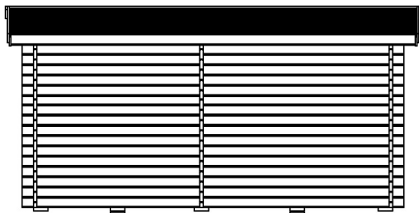
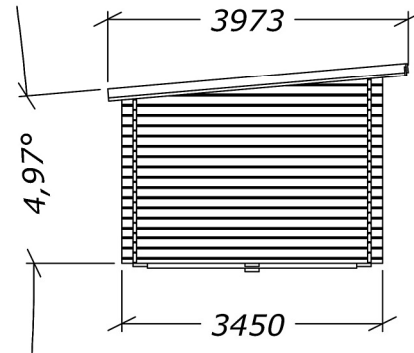
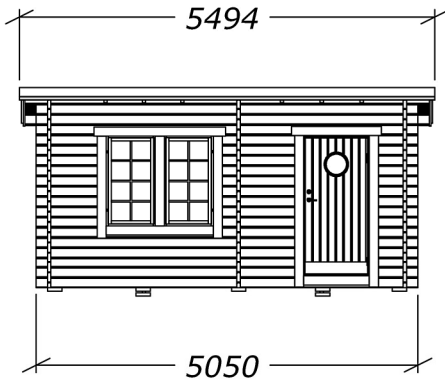

Bastun levereras med 3st fönster. De två på framsidan är ej flyttbara. Ett fönster kan placeras på valfri plats och med valfri orientering.

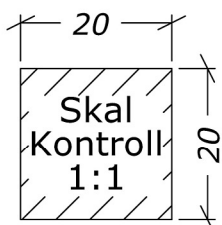
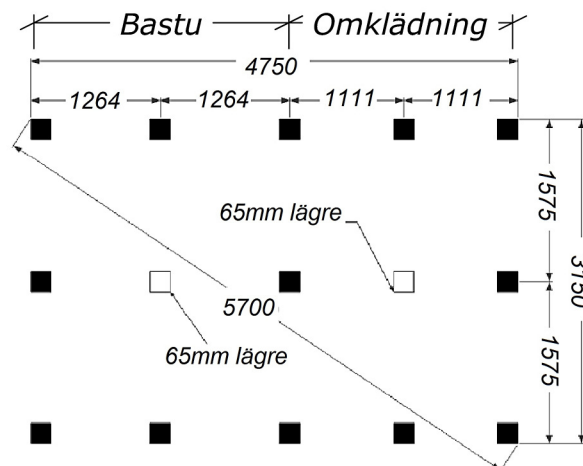

(Plintritning 1:75)